

FURUNO

OPERATOR'S MANUAL

MULTI DISPLAY

MODEL RD-30



FURUNO ELECTRIC CO., LTD.
NISHINOMIYA, JAPAN

© **FURUNO ELECTRIC CO., LTD.**

9-52 Ashihara-cho,
Nishinomiya, Japan

Telephone : 0798-65-2111
fax : 0798-65-4200

Your Local Agent/Dealer

All rights reserved.

Printed in Japan

PUB.No. OME-44130

(DAMI) RD-30

FIRST EDITION : MAR. 2001

H : MAR. 03,2004



* 0 0 0 8 0 9 1 7 7 0 5 *



* O M E 4 4 1 3 0 H 0 0 *



SAFETY INSTRUCTIONS



WARNING

Do not open the equipment.

Only qualified personnel should work inside the equipment.

Do not disassemble or modify the equipment.

Fire, electrical shock or serious injury can result.

Immediately turn off the power at the switchboard if the equipment is emitting smoke or fire.

Continued use of the equipment can cause fire or electrical shock. Contact a FURUNO agent for service.

Keep heater away from equipment.

A heater can melt the equipment's power cord, which can cause fire or electrical shock.



CAUTION

Do not use the equipment for other than its intended purpose.

Improper use of the equipment can affect performance and void the warranty.

TABLE OF CONTENTS

FOREWORD	iii
SYSTEM CONFIGURATION	iv
1. OPERATION	1-1
1.1 Controls.....	1-1
1.2 Turning On/Off the Power	1-2
1.3 Adjusting Key Panel Dimmer, Display Contrast	1-2
1.4 Selecting a Display	1-3
1.4.1 Sample displays.....	1-4
1.5 Setting up the Displays	1-8
1.5.1 Choosing display type	1-8
1.5.2 Setting up digital displays	1-9
1.5.3 Setting up graph displays....	1-10
1.5.4 Setting up graphic displays .	1-13
1.6 Displaying Rx Data	1-14
1.7 Alarms	1-15
1.7.1 Audio alarm type	1-15
1.7.2 Speed alarm	1-16
1.7.3 Water temperature alarm	1-16
1.7.4 Depth alarm.....	1-17
1.7.5 Arrival alarm, anchor watch alarm	1-18
1.7.6 XTE (Cross Track Error) alarm	1-19
1.7.7 Trip alarm	1-19
1.7.8 Odometer alarm	1-20
1.7.9 Time alarm	1-20
1.7.10 Countdown alarm	1-20
1.7.11 Alarm messages	1-21
1.8 Resetting Indications to Zero	1-22
1.9 Choosing Units of Measurement ...	1-23
1.10 Applying an Offset to Data	1-24
1.11 Choosing Time Display Format.....	1-25
1.12 Choosing Position Data Format....	1-26
1.13 Simulation Mode	1-27
1.14 I/O Port Setup	1-27
1.15 Bearing Reference	1-28
1.16 Magnetic Variation.....	1-29
1.17 Heading Sensor PG-1000, C-2000 Setup.....	1-30
2. MAINTENANCE, TROUBLESHOOTING	2-1
2.1 Maintenance.....	2-1
2.2 Error Messages.....	2-1
2.3 Diagnostic Test.....	2-2
2.4 When BATTERY ALARM! Appears..	2-3
2.5 Clearing Backup Data	2-4
MENU TREE	M-1
LORAN C/ A CHAINS	M-3
DECCA CHAINS.....	M-4
SPECIFICATIONS	SP-1
INDEX	Index-1

FOREWORD

A Word to the Owner of the RD-30 Multi Display

FURUNO Electric Company thanks you for purchasing the RD-30 Multi Display. We are confident you will discover why the FURUNO name has become synonymous with quality and reliability.

For over 50 years FURUNO Electric Company has enjoyed an enviable reputation for quality and reliability throughout the world. This dedication to excellence is furthered by our extensive global network of agents and dealers.

Your Multi Display is designed and constructed to meet the rigorous demands of the marine environment. However, no machine can perform its intended function unless properly installed and maintained. Please carefully read and follow the operation and maintenance procedures set forth in this manual.

We would appreciate feedback from you, the end-user, about whether we are achieving our purposes.

Thank you for considering and purchasing FURUNO.

Features

The RD-30 accepts a wide variety of navigation data and displays them in digital, graph and graphic (analog) formats. The user may arrange the data in five displays and show those displays in the order desired.

The main features of the RD-30 are

- Compact display unit features easy-to-view backlit 4.5" LCD.
- Five user programmable displays.
- Highway display provides graphic presentation of ship's progress toward destination waypoint.
- Ten alarm functions: Arrival/anchor watch, speed, water temperature, depth, cross-track error, trip (two), alarm clock, countdown timer, no position fixing and no position data.
- Offset function for refining accuracy of data.
- AIRMAR Co. depth, temperature and speed sensors available.

SYSTEM CONFIGURATION

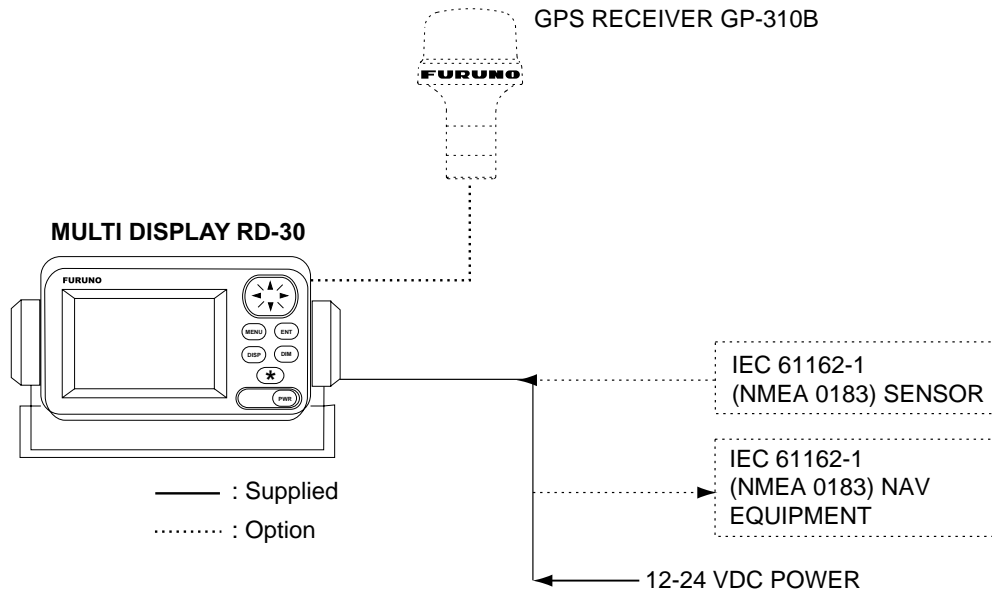

Example of single display unit connection

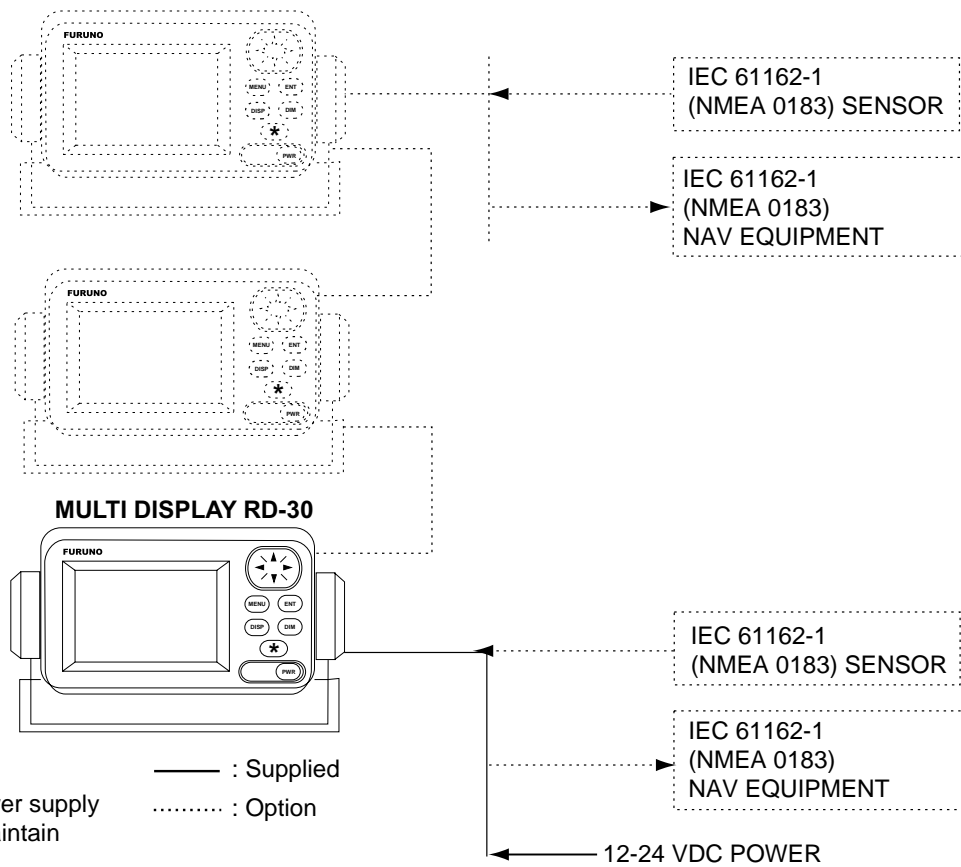

Example of multiple display unit connection

1. OPERATION

This chapter covers operation of the equipment, from turning on and off the equipment to how to set up the various displays.

1.1 Controls

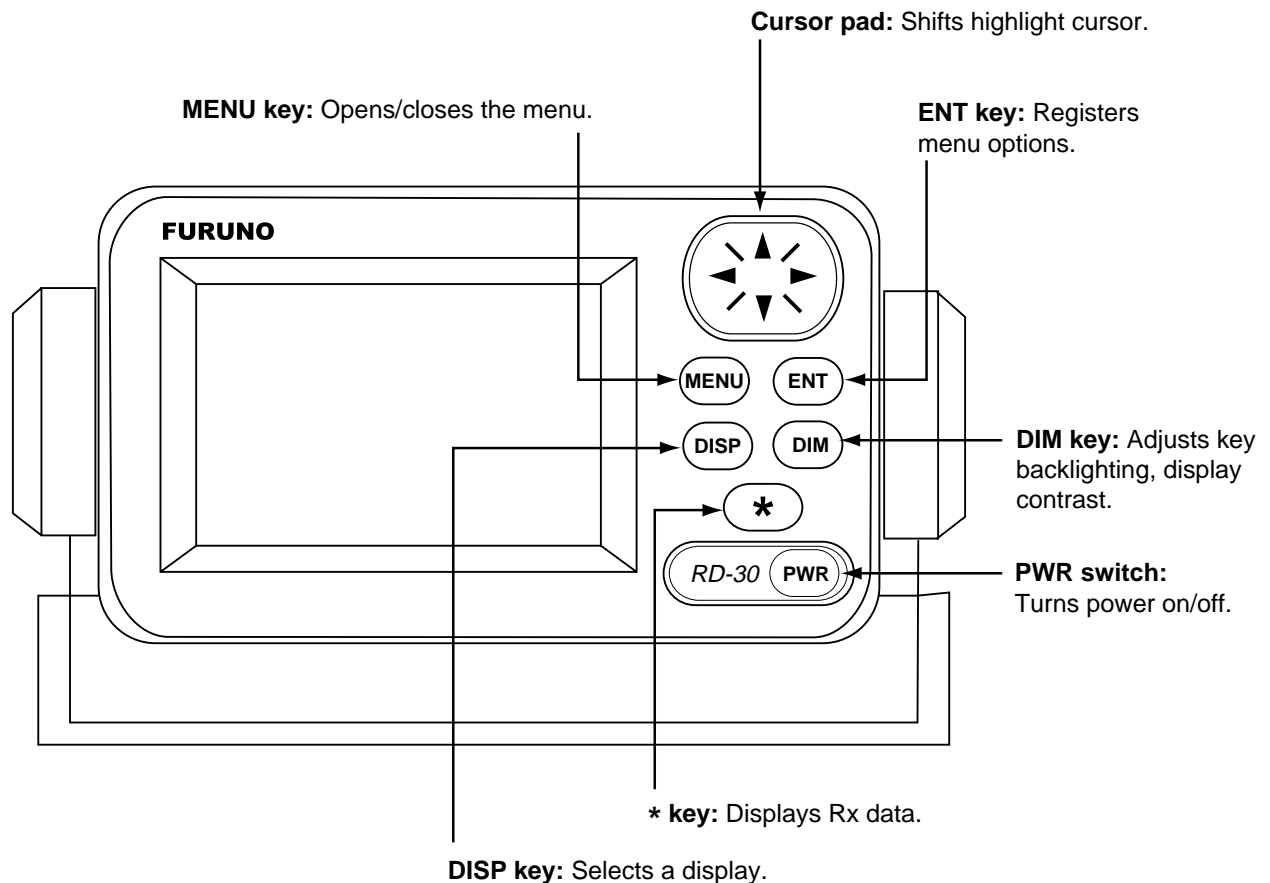

RD-30

How to remove the cover

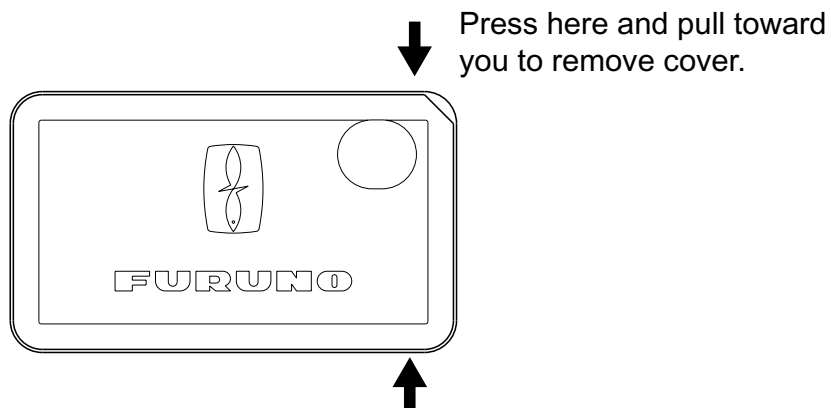

1.2 Turning On/Off the Power

Turning on: Press the [PWR] switch. Release it when you hear a beep. The screen shows the last-used display.

Turning off: Press the [PWR] switch. Release it when the screen becomes blank.

1.3 Adjusting Key Panel Dimmer, Display Contrast

1. Press the [DIM] key to show the dimmer, contrast window.

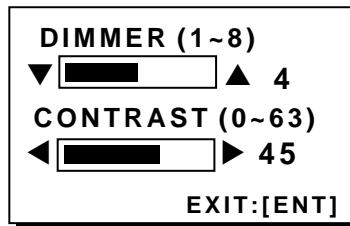

Dimmer, contrast window

2. Press ▲ or ▼ to adjust key panel dimmer.
3. Press ◀ or ▶ to adjust display contrast.
4. Press the [ENT] key to close the dimmer, contrast window.

Note: If you turn off the power with a contrast setting of less than 36, contrast is automatically set to 36 when you turn on the power again.

1.4 Selecting a Display

The RD-30 has four display types, digital, graph, graphic (analog) and highway. The operator may arrange data for five displays and show them in the order desired. Availability of data depends on the sensors connected.

Press the [DISP] key consecutively to select a display. Below is the default display sequence and default digital data items.

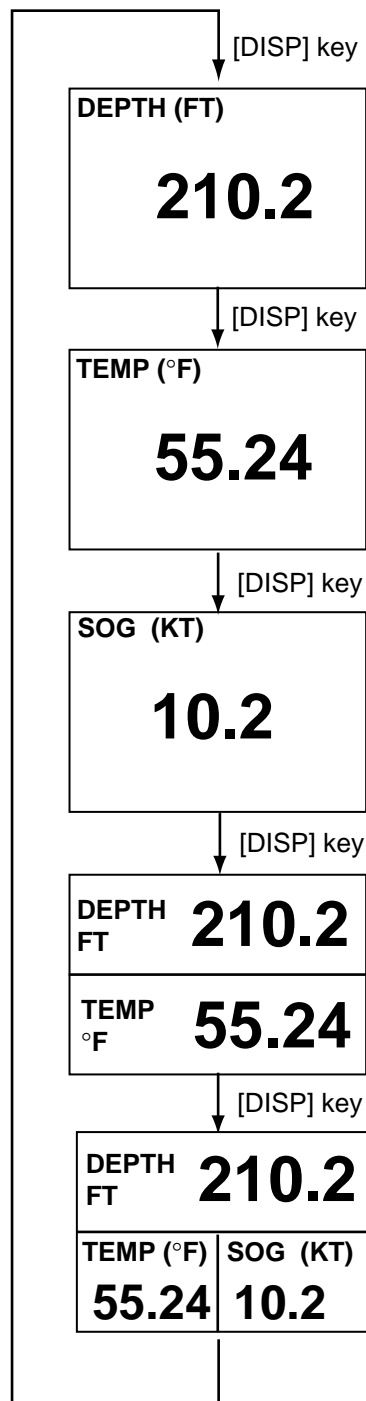

Displays (default setting)

1.4.1 Sample displays

Graph displays

Water temperature, depth, speed over ground, speed through water, wind, current data and atmospheric pressure can be shown in graph form.

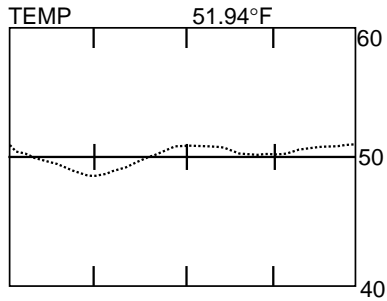

Water temperature graph

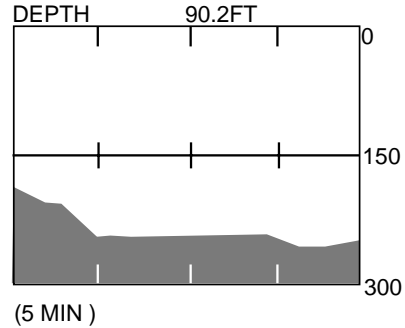

Depth graph

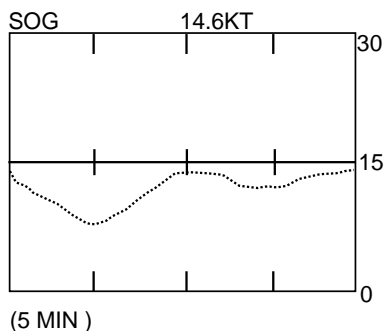

Speed over ground graph

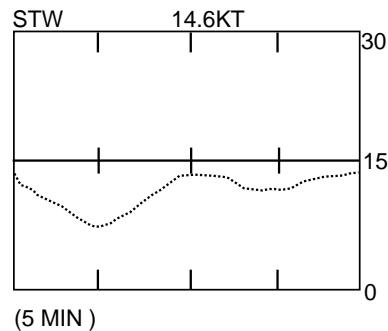

Speed through water graph

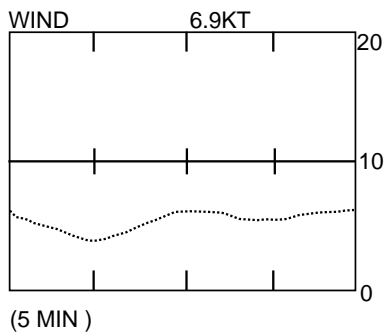

Wind graph

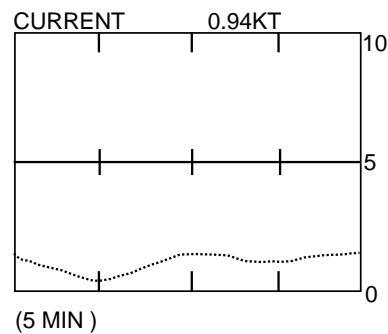

Current graph

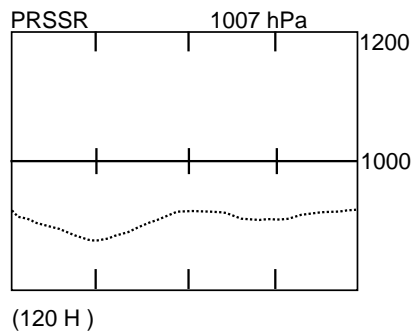

Atmospheric pressure graph

Graph displays

Graphic displays

The graphic display presents speed, temperature, wind, compass and current data in analog and digital formats.

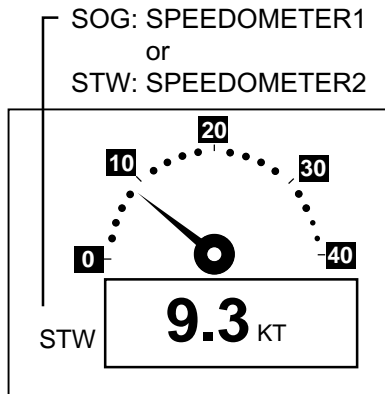

Speedometer graphic display

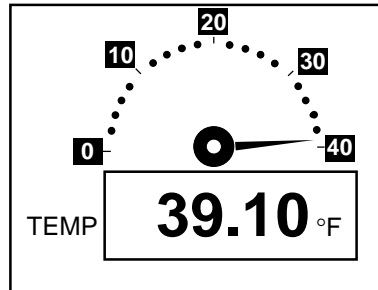

Water temperature graphic display

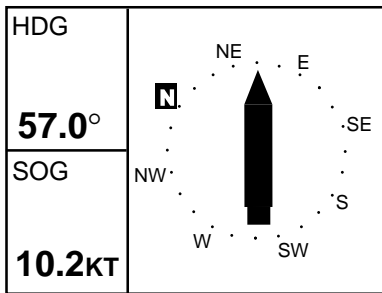

Compass graphic display

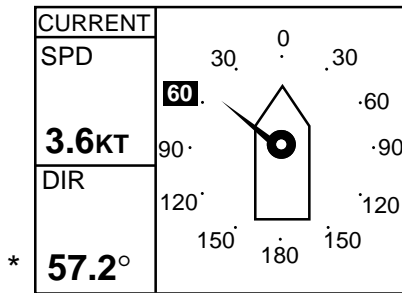

Current graphic display

* = True bearing shown as "°"; magnetic bearing as "°M".

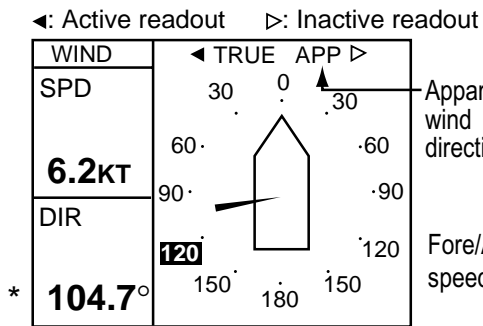

Wind graphic display

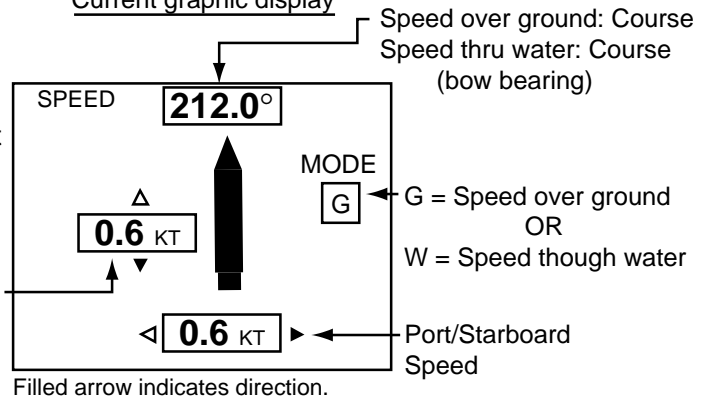

Speed graphic display (SOG or STW)

Speed over ground: Course
Speed thru water: Course
(bow bearing)

G = Speed over ground
OR
W = Speed through water

Fore/Aft speed

Port/Starboard Speed

Filled arrow indicates direction.

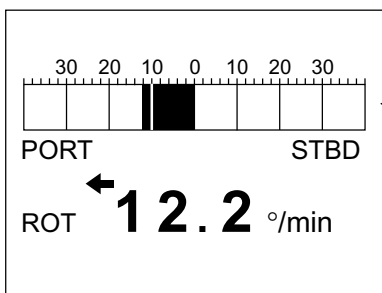

ROT (Rate Of Turn display)

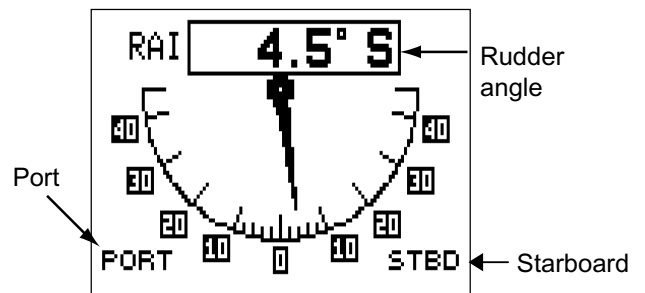

RAI (Rudder Angle Indicator)

➔ : right turn
➔ : left turn

Graphic displays

The highway display

The highway display provides a graphic presentation of ship's progress towards a destination, together with range and bearing to the destination, and ship's course and speed. To choose this display, select HIGHWAY from the USER DISPLAY SETUP menu, referring to the procedure on page 1-8.

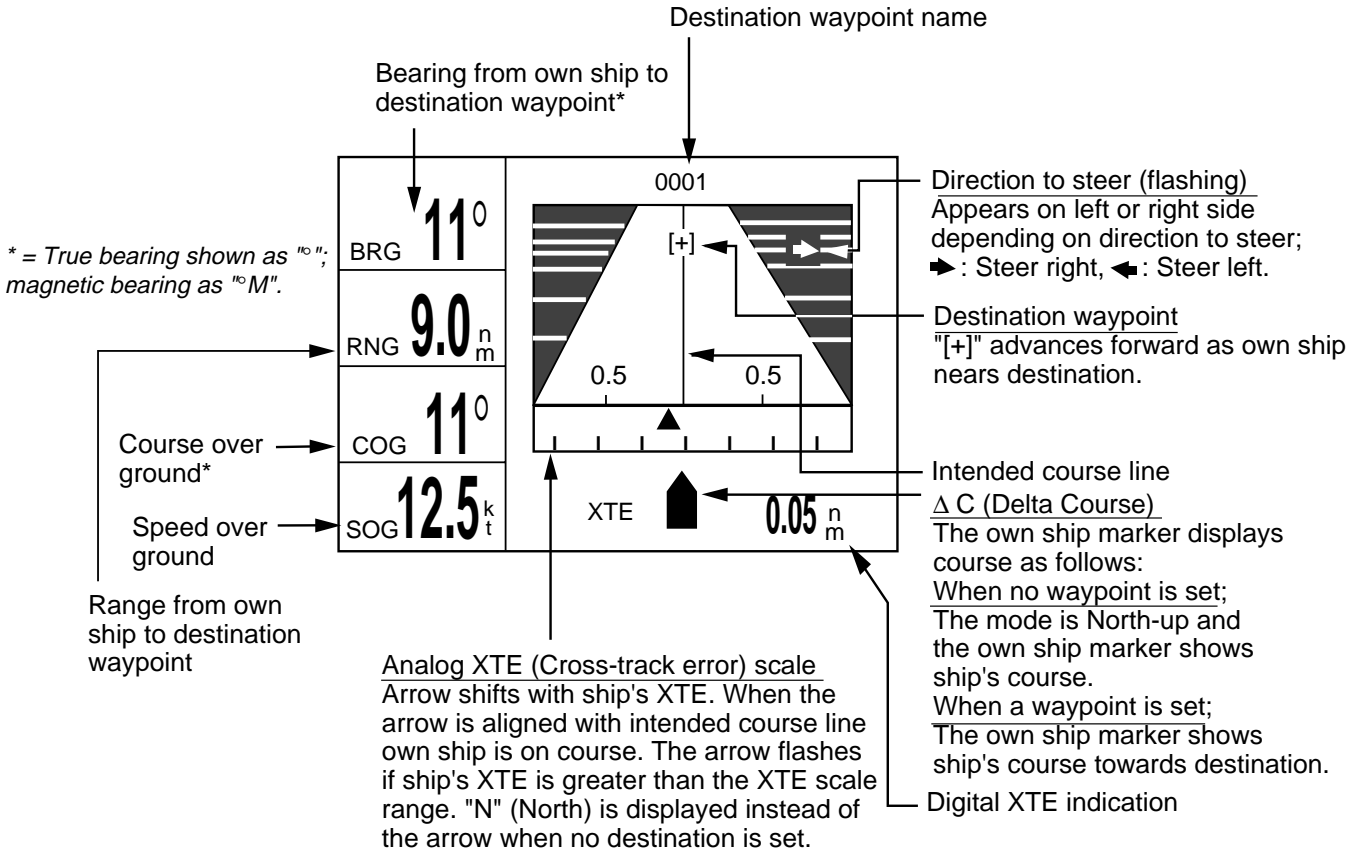

Highway display

Selecting the display range for the highway display

You may select the display range for the highway display among 0.2, 0.4, 0.8, 1, 2, 4, 8 and 16 nautical miles. (Nautical miles is the default range unit; kilometer and statute mile are also available. See page 1-23.)

1. Press the [DISP] key to show the highway display and then press the [MENU] key to show the zoom window.

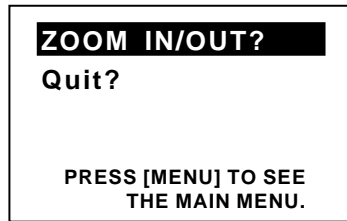

Zoom window

2. Press the [ENT] key to show the zoom setting window.

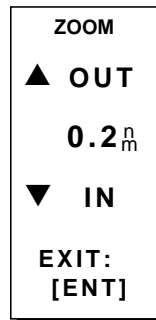

Zoom setting window

3. Press ▲ or ▼ to select zoom range desired. Setting range is shown in the table below.
4. Press the [ENT] key to finish.

Unit	Display range
nm	0.2, 0.4, 0.8, 1, 2, 4, 8, 16
km	0.2, 0.4, 1, 2, 4, 10, 20, 30
sm	0.2, 0.4, 0.8, 1, 2, 4, 8, 16

1.5 Setting up the Displays

Four display types are available: digital, graph, graphic, and highway. You may freely select and arrange what data to display in the digital, graph and graphic displays. The order in which displays are shown may also be changed. Note that the highway display cannot be adjusted.

1.5.1 Choosing display type

1. Press the [MENU] key once (twice when Highway display is shown) to open the main menu.

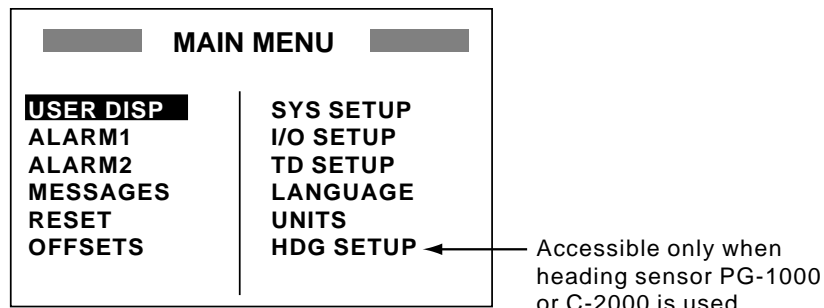

Main menu

2. Use the cursor pad to select USER DISP and then press the [ENT] key.

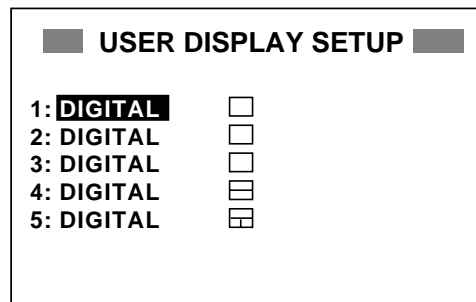

User display setup menu

Note: 1-5 show the currently selected display type.

3. Use the cursor pad to select display number desired and then press the [ENT] key.

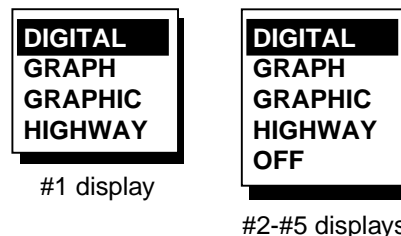

User display options

4. Select display type among DIGITAL, GRAPH, GRAPHIC, HIGHWAY and OFF as appropriate and then press the [ENT] key.
5. For digital, graph and graphic follow one of the procedures on the next several pages to choose the data to display.

1.5.2 Setting up digital displays

1. Select DIGITAL referring to paragraph 1.5.1.
2. Press the [ENT] key to show the digital display division options window.

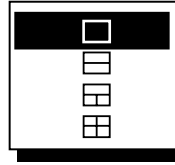

Digital display division options window

3. Select the display division desired, that is, the number of indications to show on a digital display, and then press the [ENT] key.

- : 1 indication
- : 2 indications
- : 3 indications
- : 4 indications

4. One of the following displays appears depending on the display division type you selected at step 3.

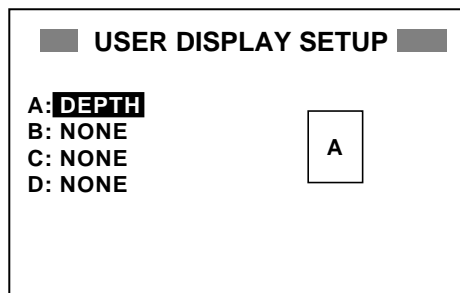

1 indication

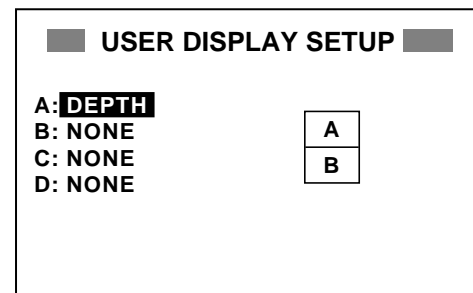

2 indications

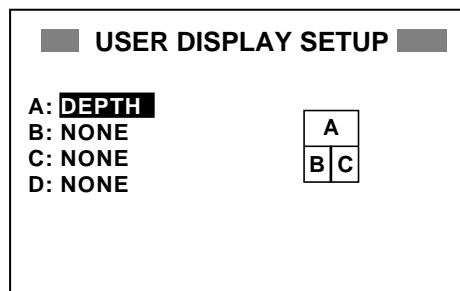

3 indications

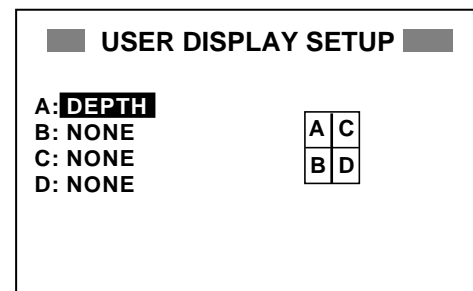

4 indications

User display setup menus (default settings)

1. OPERATION

5. Use the cursor pad to select "A" and then press the [ENT] key. The data available for display is shown.

NONE	WIND	TIMER
TEMP	ODO	POWER
DEPTH	TRIP	CUR
SOG	POSN	PRE
STW	TD	A-TEMP
HDG	TIME	HUM
COG	WPT	NONE
XTE	ROT	ETA

Digital display options

6. Select data desired and then press the [ENT] key. (All data require appropriate sensors.)

NONE: No display
TEMP: Water temperature
DEPTH: Depth
SOG: Speed over ground
STW: Speed through water
HDG: Heading
COG: Course over ground
XTE: Cross-track error
WIND: Wind speed and direction
ODO: Odometer
TRIP: Trip distance
CUR: Current (tide)
POSN: Position in latitude and longitude
TD: Position in Loran C or Decca TDs
TIME: Date and time
WPT: Waypoint (selected at navigator)
ROT: Rate of turn
TIMER: Remaining time for time alarm
POWER: Power source voltage
CUR: Current (tide) speed and direction
PRE: Atmospheric pressure
A-TEMP: Atmosphere temperature
HUM: Humidity (relative or absolute)
ETA: Estimated Time of Arrival (at destination waypoint)

7. For 2-, 3- and 4-indication displays repeat step 5-6 to select data as appropriate.

Note 1: A digital display shows bars (-) where corresponding data is not available or input is lost.

Note 2: ETA display requires the sentences ZDA and ZTG or ZTG and RMC.

8. Press the [MENU] key twice to close the menu.

1.5.3 Setting up graph displays

1. Select GRAPH referring to paragraph 1.5.1.
2. Press the [ENT] key to show the graph display options window.

TEMP
DEPTH
SOG
STW
WIND
CURRENT
PRESSURE

Graph display options window

3. Choose the graph display option desired and then press the [ENT] key. One of the following graph display setup menus appears depending on your selection.

GRAPH
< TEMP GRAPH SETUP >
BASE POINT : + 50°F
RANGE : 10°F
PERIOD : 5MIN

Temperature graph setup menu

GRAPH
< DEPTH GRAPH SETUP >
START FROM: + 0FT
MAX. RANGE: 300FT
PERIOD : 5MIN

Depth graph setup menu

GRAPH
< SOG GRAPH SETUP >
START FROM: + 0KT
MAX. RANGE: 30KT
PERIOD : 5MIN

Speed-over-ground graph setup menu

GRAPH
< STW GRAPH SETUP >
START FROM: + 0KT
MAX. RANGE: 30KT
PERIOD : 5MIN

Speed-through-water graph setup menu

GRAPH
< WIND GRAPH SETUP >
START FROM: + 0KT
MAX. RANGE: 20KT
PERIOD : 5MIN

Wind graph setup menu

GRAPH
CURRENT GRAPH SETUP
START FROM: + 0KT
MAX. RANGE: 10KT
PERIOD : 5MIN

Current graph setup menu

GRAPH
< PRESSURE GRAPH SETUP >
START FROM: + 0800 hPa
MAX. RANGE: 1200 hPa
PERIOD : 5MIN

Atmospheric pressure graph setup menu

Graph display setup menus

Note: The setting of PERIOD of each graph setup is linked, that is, it can not be set individually for each graph setup.

1. OPERATION

- Use the cursor pad to select an item and then press the [ENT] key. The far-left digit is selected by the cursor in the case where you enter data, or a pop window appears with options. Enter and select data referring to the table below.

To enter numeric data: Use ◀ or ▶ to select location and ▲ or ▼ to enter value and change from plus to minus and vice versa.

For pop-up window: Use the cursor pad to select desired option.

Graph setup menus

Menu	Item Description	Setting Range	Default Setting
Temp Graph Setup	Base Point: Set reference temperature. Range: Set the range for the graph. Period: Set the interval at which to update graph data.	Base Point: -99°F - +999°F Range: 1°F -900°F Period: 5, 30 min; 1, 3, 6, 12, 24, 48, 72, real*	Base Point: +50°F Range: 10°F Period: 5 min
Depth Graph Setup	Start From: Set starting depth. Max Range: Set the range for the graph. Period: Set the interval at which to update graph data.	Start From: 0-9998 ft Max Range: 1-9999 ft Period: 5, 30 min; 1, 3, 6, 12, 24, 48, 72, real*	Start From: + 0 ft Max Range: 300 ft Period: 5 min
SOG Graph Setup	Start From: Set starting speed. Max Range: Set the range for the graph. Period: Set the interval at which to update graph data.	Start From: 0-998 kt Max Range: 1-999 kt Period: 5, 30 min; 1, 3, 6, 12, 24, 48, 72, real*	Start From: + 0 kt Max Range: 30 kt Period: 5 min
STW Graph Setup	Start From: Set starting speed. Max Range: Set the range for the graph. Period: Set the interval at which to update graph data.	Start From: 0-998 kt Max Range: 1-999 kt Period: 5, 30 min; 1, 3, 6, 12, 24, 48, 72, real*	Start From: + 0 kt Max Range: 30 kt Period: 5 min
Wind Graph Setup	Start From: Set starting wind speed. Max Range: Set the range for the graph. Period: Set the interval at which to update graph data.	Start From: 0-998 kt Max Range: 1-999 kt Period: 5, 30 min; 1, 3, 6, 12, 24, 48, 72, real*	Start From: + 0 kt Max Range: 20 kt Period: 5 min
Current Graph Setup	Start From: Set starting current speed. Max Range: Set the range for the graph. Period: Set the interval at which to update graph data.	Start From: 0-998 kt Max Range: 1-999 kt Period: 5, 30 min; 1, 3, 6, 12, 24, 48, 72, real*	Start From: +0 kt Max Range: 20 kt Period: 5 min
Pressure Graph Setup	Start From: Set starting pressure. Max. Range: Set the range for the graph. Period: Set the interval at which to update graph data.	Start From: 0800-1199 hPa Max Range: 0801-1200 hPa Period: 5, 30 min; 1, 3, 6, 12, 24, 48, 72, real*	Start From: + 0800 hPa Max Range: 1200 hPa Period: 5 min

* = Every second

- Press the [ENT] key to register setting.
- Press the [MENU] key twice to close the menu.

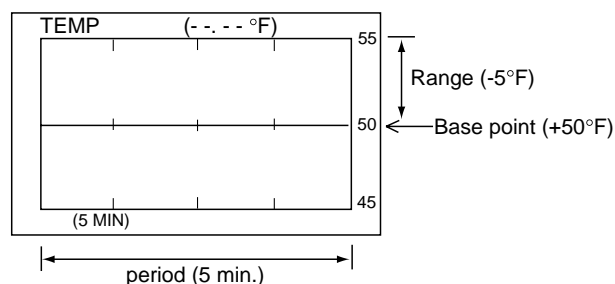

1.5.4 Setting up graphic displays

1. Select GRAPHIC referring to paragraph 1.5.1.
2. Press the [ENT] key to show the graphic display options window.

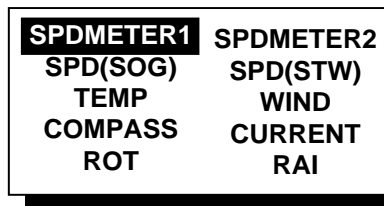

Graphic display options window

3. Select graphic display desired and then press the [ENT] key. For water temperature, speedometer1 or speedometer2 one of the following displays appears; go to step 4. For wind, compass, current or RAI no further operation is necessary; press the [MENU] key twice to close the menu. For ROT, choose ROT max. range among 30°, 60°, 90°/min.

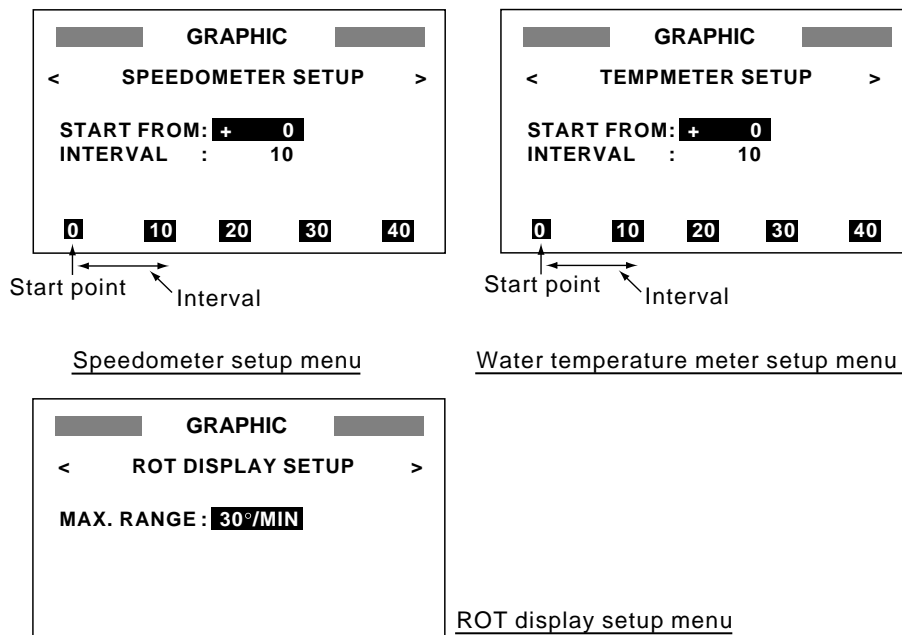

Speedometer setup menu

Water temperature meter setup menu

ROT display setup menu

Speedometer and water temperature graphic menus

4. Press the [ENT] key.
5. Use ◀ or ▶ to select location and ▲ or ▼ to enter value and switch from plus to minus and vice versa. The setting range is -99 to +99.
6. Press the [ENT] key, and the cursor shifts to INTERVAL.
7. Press the [ENT] key.
8. Enter scale interval: Use ◀ or ▶ to select location and ▲ or ▼ to enter value. The setting range is 1 to 99.
9. Press the [ENT] key.
10. Press the [MENU] key twice to close the menu.

Note: The settings of START FROM and INTERVAL on the SPEEDOMETER and TEMPMETER SETUP are linked. Therefore they can not be set individually.

1.6 Displaying Rx Data

Data currently being received can be shown by using the [*] key. Below is a sample Rx data display.

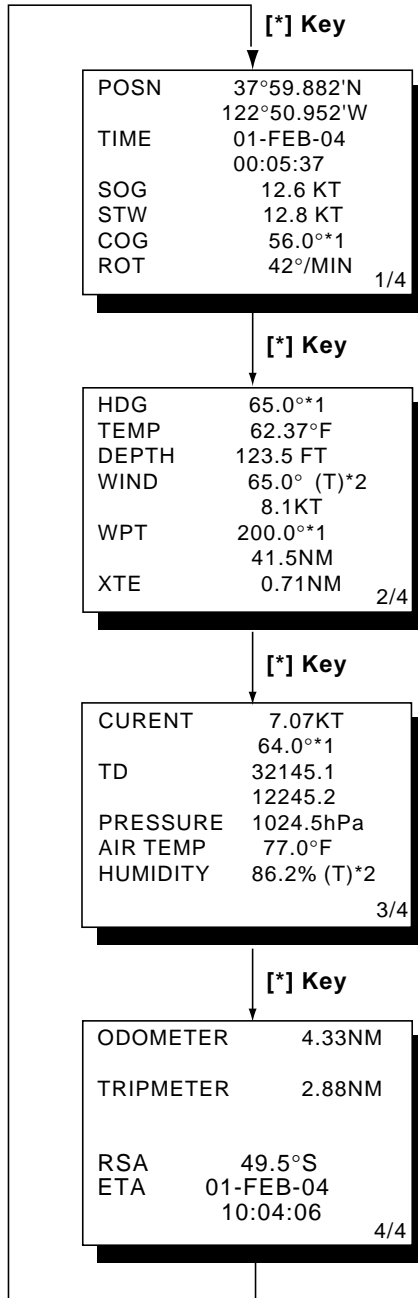

*1 = True bearing shown as "°";
magnetic bearing as "M".
*2 = True direction shown as "T";
apparent direction shown as "A".

Rx data display

1.7 Alarms

The RD-30 has ten conditions which can trigger audio and visual alarms: speed, water temperature, depth, arrival/anchor watch, cross-track error, trip distance (two alarms), countdown timer, alarm clock, no position fixing and no position data.

Note: You can not turn off the no position fixing alarm nor the no position data alarm.

1.7.1 Audio alarm type

Audio and visual alarms are released whenever an alarm setting is violated. You can select the audio alarm type as follows:

1. Press the [MENU] key once or twice to show the main menu.
2. Select ALARM1 and then press the [ENT] key.

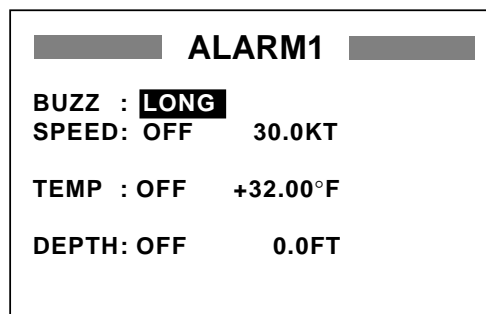

ALARM1 menu

3. Press the [ENT] key to open the buzzer options window.



Buzzer options window

4. Use the cursor pad to select alarm type desired and then press the [ENT] key.

SHORT: Two short beeps
LONG: Three long beeps
CONTIN.: Continuous beep

5. Press the [MENU] key twice to close the menu.

1.7.2 Speed alarm

The speed alarm warns when your boat's speed is lower or higher than the speed setting, or is inside or outside of the speed range setting.

1. Press the [MENU] key once or twice to show the main menu.
2. Select ALARM1 and then press the [ENT] key.
3. Select SPEED and then press the [ENT] key to show the speed alarm options window.

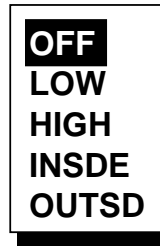

Speed alarm options window

4. Select alarm type desired and then press the [ENT] key.
 - OFF:** Turns off the speed alarm.
 - LOW:** Alarm triggered when speed is lower than the speed setting.
 - HIGH:** Alarm triggered when speed is higher than the speed setting.
 - INSDE:** Alarm triggered when speed is inside the speed range setting.
 - OUTSD:** Alarm triggered when speed is outside of the speed range setting.
5. If you turned on the alarm, press the [ENT] key and then use the cursor pad to enter the alarm setting: Use ◀ or ▶ to select location, and press ▲ or ▼ to enter value. For INSDE and OUTSD, enter lower value on top, higher value below.
6. Press the [ENT] key.
7. Press the [MENU] key twice to close the menu.

1.7.3 Water temperature alarm

The water temperature alarm warns when the water temperature is lower or higher than the temperature setting, inside or outside of the temperature range setting, or the temperature varies by the temperature set within one minute (shear).

1. Press the [MENU] key once or twice to show the main menu.
2. Select ALARM1 and then press the [ENT] key.
3. Select TEMP and then press the [ENT] key to show the water temperature alarm options window.

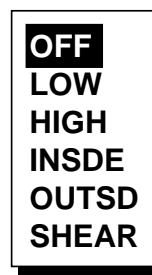

Temperature alarm options window

4. Select alarm type desired and then press the [ENT] key.
 - OFF:** Turns off the water temperature alarm.
 - LOW:** Alarm triggered when the water temperature is lower than the water temperature setting.
 - HIGH:** Alarm triggered when the water temperature is higher than the water temperature setting.
 - INSDE:** Alarm triggered when the water temperature is inside the water temperature range setting.
 - OUTSD:** Alarm triggered when the temperature is outside of the water temperature range setting.
 - SHEAR:** Alarm triggered when the water temperature varies more than the temperature setting within one minute.
5. If you turned on the alarm, press the [ENT] key and then use the cursor pad to enter the alarm setting: Use ◀ or ▶ to select location, and press ▲ or ▼ to enter value. For INSDE and OUTSD, enter lower value on top, higher value below.
6. Press the [ENT] key.
7. Press the [MENU] key twice to close the menu.

1.7.4 Depth alarm

The depth alarm warns when the depth is lower or higher than the depth setting, or is inside or outside of the depth range setting.

1. Press the [MENU] key once or twice to show the main menu.
2. Select ALARM1 and then press the [ENT] key.
3. Select DEPTH and then press the [ENT] key to show the depth alarm options window.



Depth alarm options window

4. Select alarm type desired and then press the [ENT] key.
 - OFF:** Turns off the depth alarm.
 - LOW:** Alarm triggered when the depth is shallower than depth setting.
 - HIGH:** Alarm triggered when the depth is deeper than depth setting.
 - INSDE:** Alarm triggered when the depth is inside the depth range setting.
 - OUTSD:** Alarm triggered when the depth is outside of the depth range setting.
5. If you turned on the alarm, press the [ENT] key and then use the cursor pad to enter the alarm setting: Use ◀ or ▶ to select location, and press ▲ or ▼ to enter value. For INSDE and OUTSD enter lower value on top, higher value below.
6. Press the [ENT] key.
7. Press the [MENU] key twice to close the menu.

1.7.5 Arrival alarm, anchor watch alarm

The arrival alarm informs you that your boat is approaching a destination waypoint. The area that defines an arrival zone is that of a circle which you approach from the outside of the circle. The alarm will be released if your boat enters the circle.

The anchor watch alarm informs you that your boat is moving when it should be at rest.

The arrival alarm and anchor watch alarm cannot be activated together. RMB, BWR or BWC data sentence required for these alarms.

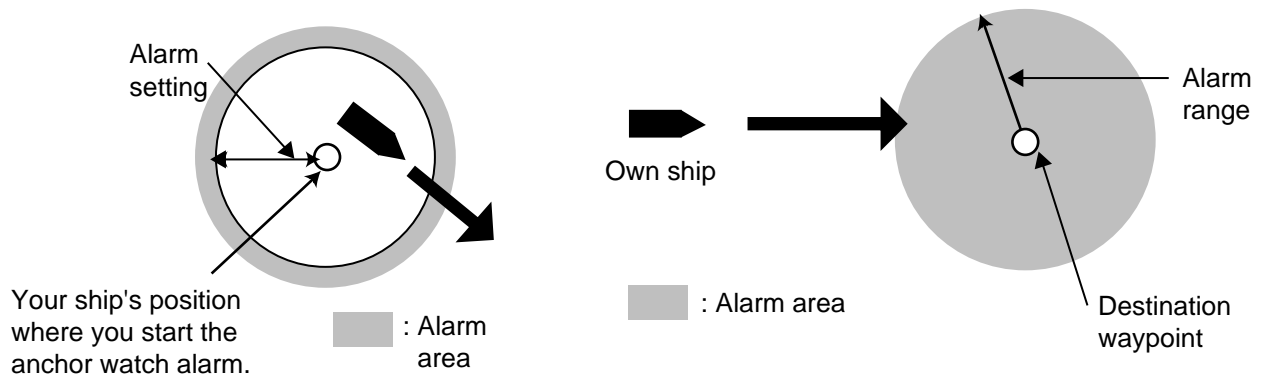

Anchor watch alarm

Arrival alarm

How the arrival alarm works

1. Press the [MENU] key once or twice to show the main menu.
2. Select ALARM2 and then press the [ENT] key.

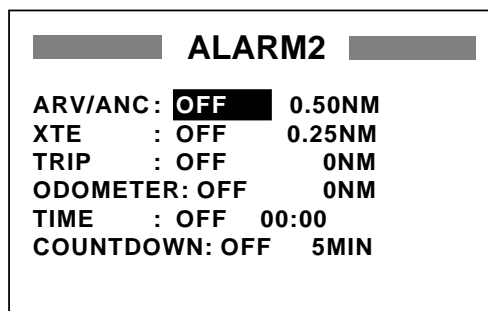

ALARM2 menu

3. Select ARV/ANC and then press the [ENT] key to show the arrival alarm/anchor watch alarm options window.

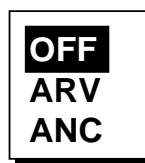

Arrival/anchor watch alarm options window

5. If you turned on the alarm, press the [ENT] key and then use the cursor pad to enter the alarm setting: Use ◀ or ▶ to select location, and press ▲ or ▼ to enter value.
6. Press the [ENT] key.
7. Press the [MENU] key twice to close the menu.

1.7.6 XTE (Cross Track Error) alarm

The XTE alarm, which requires the XTE data sentence, warns you when your boat is off its intended course.

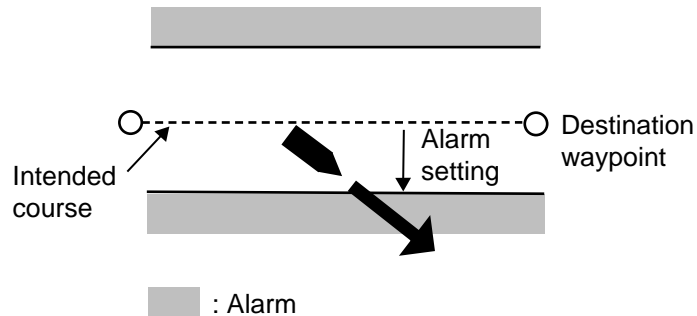

How the XTE alarm works

1. Press the [MENU] key once or twice to show the main menu.
2. Select ALARM2 and then press the [ENT] key.
3. Select XTE and then press the [ENT] key to show the XTE alarm options window.
4. Select OFF or ON as appropriate and then press the [ENT] key.
5. For ON, press the [ENT] key and then use the cursor pad to enter the alarm setting: Use ◀ or ▶ to select location, and press ▲ or ▼ to enter value.
6. Press the [ENT] key.
7. Press the [MENU] key twice to close the menu.

1.7.7 Trip alarm

The trip alarm informs you when you have traveled a certain distance.

1. Press the [MENU] key once or twice to show the main menu.
2. Select ALARM2 and then press the [ENT] key.
3. Select TRIP and then press the [ENT] key to show the trip alarm options window.
4. Select OFF or ON as appropriate and then press the [ENT] key.
5. For ON, press the [ENT] key and then use the cursor pad to enter the alarm setting: Use ◀ or ▶ to select location, and press ▲ or ▼ to enter value.
6. Press the [ENT] key.
7. Press the [MENU] key twice to close the menu.

Note: Speed through water must be more than 0.09 kt to calculate trip distance.

1.7.8 Odometer alarm

The odometer alarm informs you when your vessel has traveled the distance you have set. Its function is similar to the trip alarm except its maximum setting is 999 (nm).

1. Press the [MENU] key once or twice to show the main menu.
2. Select ALARM2 and then press the [ENT] key.
3. Select ODOMETER and then press the [ENT] key to show the odometer alarm options window.
4. Select OFF or ON as appropriate and then press the [ENT] key.
5. For ON, press the [ENT] key and then use the cursor pad to enter the alarm setting: Use ◀ or ▶ to select location, and press ▲ or ▼ to enter value.
6. Press the [ENT] key.
7. Press the [MENU] key twice to close the menu.

Note: Speed through water must be more than 0.09 kt to calculate odometer distance.

1.7.9 Time alarm

The time alarm works like an alarm clock, generating visual and audio alarms when the preset time arrives. Requires ZDA or GGA data sentence.

1. Press the [MENU] key once or twice to show the main menu.
2. Select ALARM2 and then press the [ENT] key.
3. Select TIME and then press the [ENT] key to show the time alarm options window.
4. Select OFF or ON as appropriate and then press the [ENT] key.
5. For ON, press the [ENT] key and then use the cursor pad to enter the time you want for the alarm: Use ◀ or ▶ to select location, and press ▲ or ▼ to enter value.
6. Press the [ENT] key.
7. Press the [MENU] key twice to close the menu.

1.7.10 Countdown alarm

The countdown alarm generates audio and visual alarms when the preset time has elapsed.

1. Press the [MENU] key once or twice to display the main menu.
2. Select ALARM2 and then press the [ENT] key.
3. Select COUNTDOWN and then press the [ENT] key to show the countdown alarm options window.
4. Select OFF or ON as appropriate and then press the [ENT] key.
5. For ON, press the [ENT] key to show the countdown alarm options window.
6. Select 5, 10 or 15 (minutes) as appropriate and then press the [ENT] key.
7. Press the [MENU] key twice to close the menu.

1.7.11 Alarm messages

When an alarm setting is violated the audio alarm sounds and the name of the offending alarm and a flashing exclamation mark appear at the top of the display. You can silence the audio alarm and erase the alarm name by pressing any key. The exclamation mark remains on the screen until the offending alarm is turned off or the cause of the alarm is eliminated.

You can see which alarm has been violated by displaying the message display, which can show up to ten messages.

1. Press the [MENU] key once or twice to display the main menu.
2. Select MESSAGES and then press the [ENT] key.

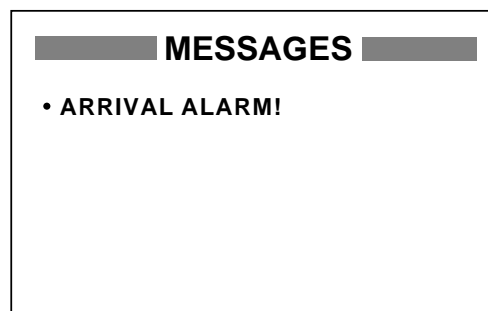

Messages display

3. Press the [MENU] key twice to close the menu.

Note: "NO FIX!" appears when a navigation device connected to the RD-30 can not fix the ship's position. "NO POSITION DATA!" appears when the own ship's position data has not been input from a navigation device for 90 seconds.

1.8 Resetting Indications to Zero

You may individually reset the trip, odometer and graph indications to zero as follows:

1. Press the [MENU] key once or twice to display the main menu.
2. Select RESET and then press the [ENT] key.

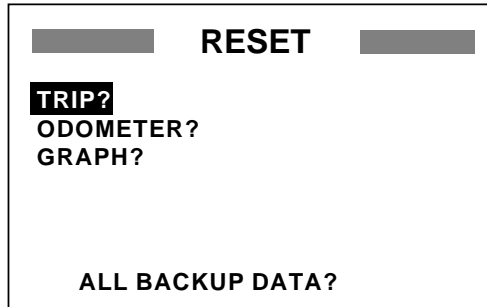

Reset menu

3. Select TRIP, ODOMETER or GRAPH as appropriate and then press the [ENT] key. One of the following displays appears depending on your selection.

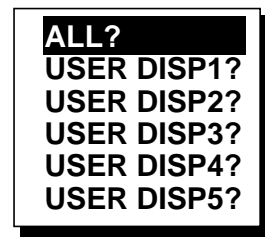
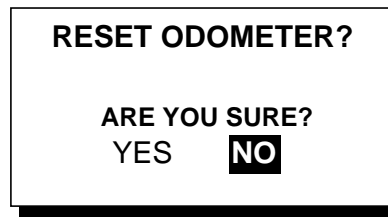

Windows for resetting trip, odometer and graph displays

4. For TRIP and ODOMETER, press ◀ to select YES and then press the [ENT] key.

For GRAPH, select specific display number (USER DISP1-USER DISP5) or ALL (resets all graphs) as appropriate and then press the [ENT] key. The display shown below appears. Press ◀ to select YES and then press the [ENT] key.

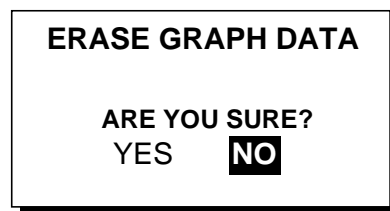

Reset graph prompt

5. Press the [MENU] key twice to close the menu.

Note: For “ALL BACKUP DATA?” see page 2-4.

1.9 Choosing Units of Measurement

You may choose the units of measurement for water temperature, distance/speed, depth and wind speed as follows:

1. Press the [MENU] key once or twice to display the main menu.
2. Select UNITS and then press the [ENT] key.

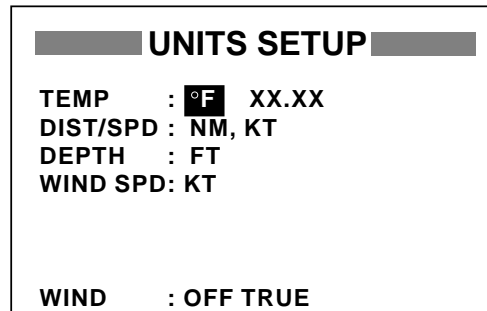

Units setup menu

3. Select TEMP, DIST/SPD, DEPTH or WIND SPD and WIND (wind speed averaging and wind direction reference) as appropriate and then press the [ENT] key. One of the following displays appears depending on the selection you made.

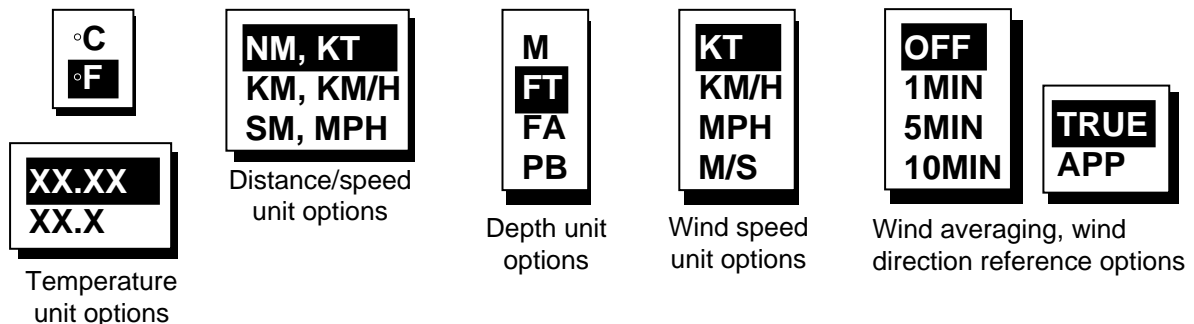

Unit options

4. Use the cursor pad to select unit desired and then press the [ENT] key. For items other than WIND, go to step 5. For WIND, do the following:
 - a) Choose an averaging time and then press the [ENT] key. Wind speed is averaged every two seconds during the period chosen. This setting also is effective for the graph and graphic displays and the wind speed shown by pressing the [*] key.
 - b) Press the [ENT] key again.
 - c) Choose TRUE or APPARENT and then press the [ENT] key.

TRUE: The speed and direction of the wind felt or measured when stationary.

APPARENT: The direction and speed of the wind as it appears to those on board, relative to the speed and direction of the boat; combination of the true wind and the wind caused by the boat's movement.

5. Press the [MENU] key twice to close the menu.

1.10 Applying an Offset to Data

An offset may be applied to speed, water temperature, depth and wind data to refine their accuracy. Further, you can use local time by entering the time difference between it and UTC time.

1. Press the [MENU] key once or twice to display the main menu.
2. Select OFFSETS and then press the [ENT] key.

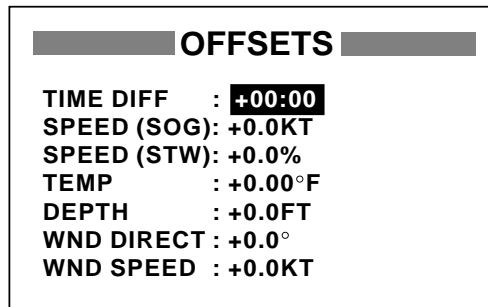

Offsets menu

3. Select appropriate item and then press the [ENT] key.
4. Use the cursor pad to enter an offset: Use ◀ or ▶ to select location, press ▲ or ▼ to enter value and switch from plus to minus and vice versa.
5. Press the [ENT] key.
6. Press the [MENU] key twice to close the menu.

1.11 Choosing Time Display Format

Time may be displayed in 12 hour or 24 hour notation as follows:

1. Press the [MENU] key once or twice to display the main menu.
2. Select SYS SETUP and then press the [ENT] key.

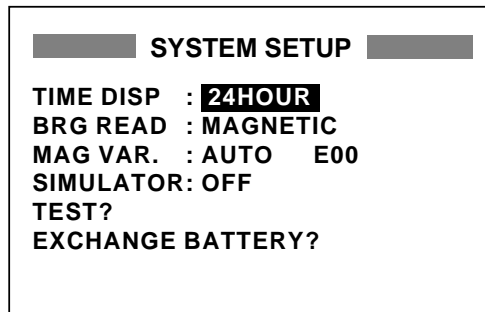

SYSTEM SETUP menu

3. Select TIME DISP and then press the [ENT] key.



Time display options

4. Select 12HOUR or 24HOUR as appropriate and then press the [ENT] key.
5. Press the [MENU] key twice to close the menu.

1.12 Choosing Position Data Format

Position may be shown in latitude and longitude or Loran/ Decca TDs. Choose L/L position format and Loran/ Decca chain and station pair as follows:

1. Press the [MENU] key once or twice to display the main menu.
2. Select TD SETUP and then press the [ENT] key.

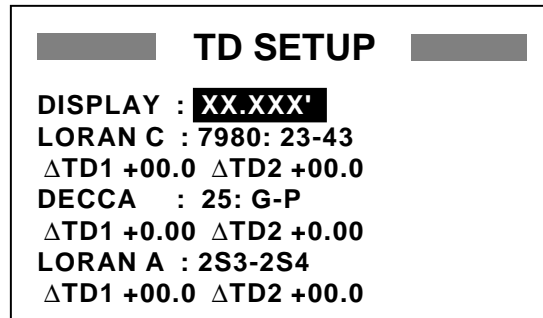

TD setup options

3. Select DISPLAY and then press the [ENT] key.

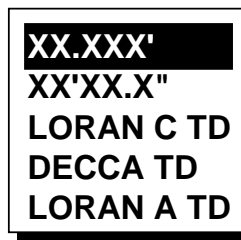

Position format options

4. Select appropriate option and then press the [ENT] key.
 - XX.XXX'**: Shows latitude and longitude position with no seconds.
 - XX'XX.X''**: Shows latitude and longitude position with seconds.
 - LORAN C TD**: Displays Loran C TDs.
 - DECCA TD**: Displays Decca TDs.
 - LORAN A TD**: Displays Loran A TDs.
5. If you selected one of the latitude and longitude options go to step 6. For "LORAN C TD", "DECCA TD" or "LORAN A TD" do the following to set chain and station pair:
 - a) Press the [ENT] key.
 - b) Press ▲ or ▼ to set chain (See page M-3 or M-4).
 - c) Press ► followed by ▲ or ▼ to set station pair.
 - d) Press the [ENT] key.
 - e) If desired you may enter an offset for TD1 and/or TD2 to refine Loran/ Decca position. Select ΔTD1 (ΔTD2) and then press the [ENT] key. Use ◀ or ▶ to select location, and press ▲ or ▼ to enter value or switch from plus to minus and vice versa.
 - f) Press the [ENT] key.
6. Press the [MENU] key twice to close the menu.

1.13 Simulation Mode

A simulation mode, showing internally generated navigation data, is provided to acquaint you with the features of the RD-30. "SIM" appears on the display when the simulation mode is turned on.

1. Press the [MENU] key once or twice to open the main menu.
2. Select SYS SETUP and then press the [ENT] key.
3. Select SIMULATOR and then press the [ENT] key.
4. Select ON or OFF as appropriate and then press the [ENT] key.
5. Press the [MENU] key twice to close the menu.

1.14 I/O Port Setup

The I/O SETUP menu sets up the IN/OUT and AUX ports on the RD-30. Additionally you can use this menu to output power to other display units, in case of multiple display units. Note that the equipment can process data input at the rate of up to 430 characters/second. Some delay will occur when processing data input at a higher rate.

1. Press the [MENU] key once or twice to open the main menu.
2. Select I/O SETUP and then press the [ENT] key.

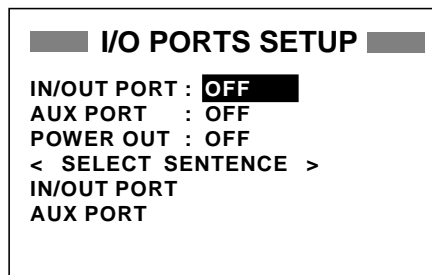

I/O PORTS SETUP menu

3. Select IN/OUT, AUX or POWER OUT as appropriate and then press the [ENT] key. One of the following displays appears depending on your selection.

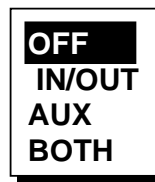

IN/OUT and
AUX options



POWER OUT
options

OFF: No output

ON: Outputs power to other display units

OFF: No output

IN/OUT: Output data which is input through the IN/OUT port

AUX: Output data which is input through the AUX port

BOTH: Output mixed data which is input through the IN/OUT and AUX ports

IN/OUT, AUX and POWER OUT options

Note: If, when BOTH is selected, the data sentence which has an input interval faster than one second (ROT, HDT, etc.) is turned on, some data may not be output.

1. OPERATION

4. Select appropriate option and then press the [ENT] key.
5. If you selected OFF for IN/OUT PORT, AUX PORT or POWER OUT go to step 8. For the option IN/OUT, AUX and BOTH, select IN/OUT PORT or AUX PORT under SELECT SENTENCE as appropriate and press the [ENT] key. One of the following displays appears.

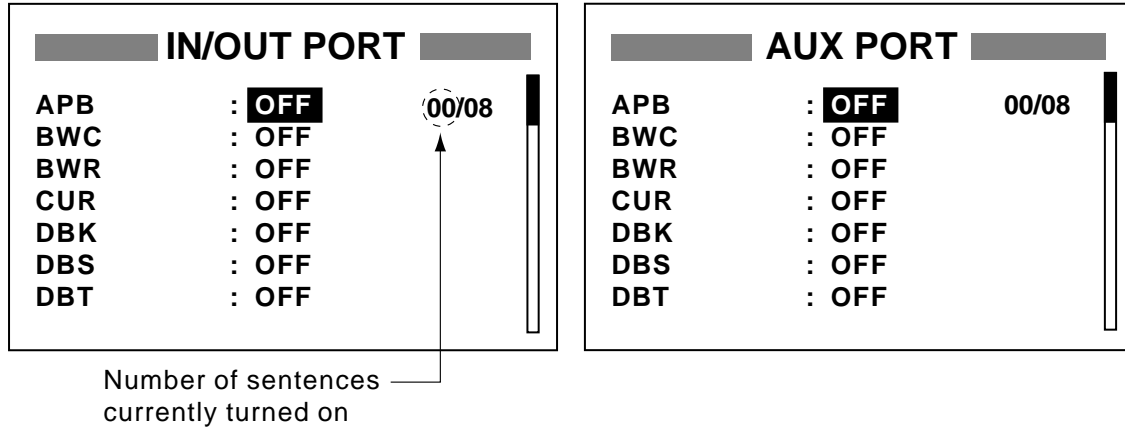

IN/PUT and AUX BOTH SETUP menu

Note: Sentences currently being received are shown in reverse video.

6. Select sentence to process and then press the [ENT] key. Use ▼ or ▲ to scroll the list.
7. Select ON or OFF as appropriate and then press the [ENT] key. You can turn eight sentences ON. The number of sentences currently turned on appears at the top right-hand corner of the menu.
8. Press the [MENU] key twice to close the menu.

For further details, see the installation manual of RD-30.

1.15 Bearing Reference

Bearings can be displayed in true or magnetic bearing. True bearing is a bearing measured using true North as the reference direction, and it is calculated by the formula True Bearing = Magnetic Bearing + Magnetic Deviation (Variation). Magnetic bearings are measured with magnetic north as the reference direction.

Magnetic bearing is calculated by adding true bearing to RD-30-stored magnetic variation. "M" appears near a bearing readout when magnetic bearings are used.

1. Press the [MENU] key once or twice to open the menu.
2. Choose SYS SETUP and then press the [ENT] key.
3. Choose BRG READ and then press the [ENT] key.



BRG READ options

4. Choose MAGNETIC or TRUE as appropriate and then press the [ENT] key.
5. Press the [MENU] key twice to close the menu.

1.16 Magnetic Variation

The location of the magnetic north pole is different from the geographical north pole. This causes a difference between the true and magnetic north direction. This difference is called magnetic variation, and varies with respect to the observation point on earth. Your unit is preprogrammed with all the earth's magnetic variation. However, you may wish to enter variation manually to refine accuracy. To use magnetic variation, "BRG READ" on the SYS SETUP menu must be set to "MAGNETIC."

1. Press the [MENU] key once or twice to open the menu.
2. Choose SYS SETUP and then press the [ENT] key.
3. Choose MAG VAR. and then press the [ENT] key.



MAG VAR. options

4. Choose AUTO or MANUAL as appropriate and then press the [ENT] key. For AUTO go to step 5. For MANUAL, enter magnetic variation as below, referring to a nautical chart:
 - a) Press the [ENT] key.
 - b) Use ▲ or ▼ to choose West or East as appropriate.
 - c) Press ► to shift the cursor one place rightward.
 - d) Use ▲ or ▼ to enter appropriate numeric.
 - e) Press ► to shift the cursor one place rightward.
 - f) Use ▲ or ▼ to enter appropriate numeric.
 - g) Press the [ENT] key.
5. Press the [MENU] key twice to close the menu.

1.17 Heading Sensor PG-1000, C-2000 Setup

Set up the heading sensor PG1000, C-2000 on the HDG SETUP menu, with the heading sensor connected to the AUX port. Note that no data is transmitted from the IN/OUT port when the HDG SETUP menu is displayed.

Calibration

Calibrate the heading sensor against magnetic field distortion aboard the boat as below. Do not turn off the power during the calibration.

1. Find a calm and clear area without current, wind, swell or waves.
2. Steer the boat clockwise or counterclockwise in a circular course. Take about two minutes to complete the circle (at about 3 kt). While turning the boat, go to step 3.

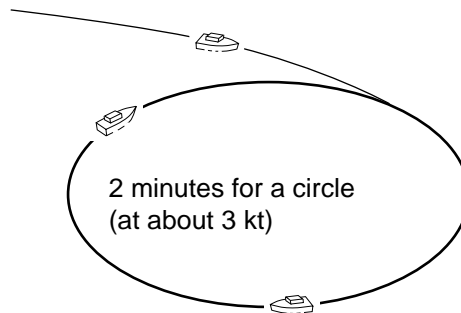

Course to follow for calibration

Notes: Speed higher than 3 kt may result in calibration error.

3. Press the [MENU] key once or twice to open the menu.
4. Choose HDG SETUP and then press the [MENU] key. (It may take several seconds before the HDG SETUP menu appears.)

HDG SENSOR SETUP

CALIBRATION

OFFSET : -14 352°M

DAMPING : 1*

← Offset output from PG-1000 or C-2000 and current bearing (updated every second)

← Damping factor set at C-2000

* = DAMPING shown on C-2000.

HDG SETUP menu

5. Choose CALIBRATION and then press the [ENT] key.

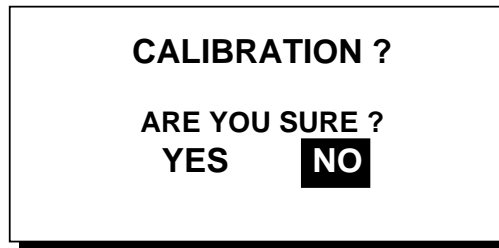

Calibration prompt

6. Choose YES and then press the [ENT] key. The display shows "CALIBRATION??" during calibration. (To cancel calibration, press the [MENU] key. You cannot cancel calibration except when SAMPLING is showing "??".)
7. Continue turning the boat in a circle until calibration results, NG (No Good) or OK, appear on the display. This takes about 3-5 circles with the PG-1000 or 2-3 circles with the C-2000. If the calibration was successful, OK appears as the results.

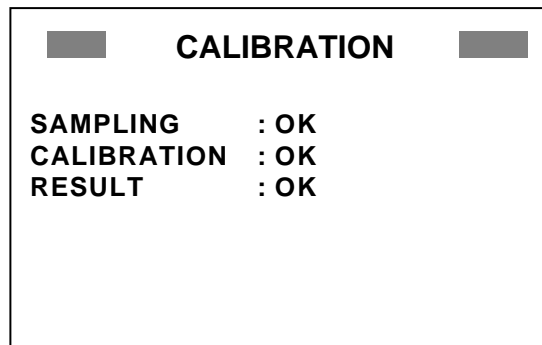

Calibration results

8. The display then shows "PUSH ENT KEY." Push the [ENT] key to return to the HDG SETUP menu.

Note: If the results were unsuccessful, NG appears as the results. In this case, press the [MENU] key or the [ENT] key to return to the HDG SETUP menu. Redo the calibration referring to the installation manual for the heading sensor.
9. If you do not need to align heading or enter a damping factor (C-2000), press the [MENU] key twice to close the menu. To align heading, go to step 10. To enter damping factor, go to step 18.

Offset

If there is a difference between sensor bearing and actual bearing, enter it as below. For example, if the sensor shows 70° and the actual bearing is 75°, enter +5(°).

10. Choose OFFSET and press the [ENT] key.
11. Use ▲ or ▼ to choose minus or plus respectively, whichever is appropriate.
12. Press ► to shift the cursor one place.
13. Use ▲ or ▼ to enter appropriate value.
14. Press ► to shift the cursor one place.
15. Use ▲ or ▼ to enter appropriate value.
16. Press the [ENT] key.
17. Press the [MENU] key twice to finish, or go to step 15 to enter damping factor (C-2000).

Damping (C-2000)

Damping determines how sensitively the sensor responds to change of ship's heading. Use a small value for faster response. "1" is the default setting. Note that damping value must be received from the C-2000 to display the item DAMPING on the HDG SETUP menu.

18. Choose DAMPING and press the [ENT] key.

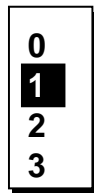

Damping options

19. Choose damping value. The larger the number the slower the response.
20. Press the [ENT] key.
21. Press the [MENU] key twice to close the menu.

2. MAINTENANCE, TROUBLESHOOTING



WARNING

Do not open the equipment.

Only qualified personnel should work inside the equipment.

2.1 Maintenance

Check the following points regularly to maintain performance:

- Check that connections on the rear panel are firmly tightened and free of dust.
- Check that the ground system is free of rust and the ground wire is tightly fastened.
- Dust and dirt on the display unit can be removed with a soft cloth. Do not use chemical cleaners to clean the display unit – they can remove paint and markings.

2.2 Error Messages

In addition to the alarm messages mentioned in Chapter 1, the RD-30 displays the following messages to alert you to possible trouble.

Message	Meaning, Remedy
BACKUP ERROR DATA!	RAM data corrupted. Try to clear backup data, referring to paragraph 2.5.
BATTERY ALARM!	Voltage of internal battery is low. Have a qualified technician replace the battery, following the procedure in paragraph 2.4.
RAM ERROR!	Request service.
ROM ERROR!	Request service.

2.3 Diagnostic Test

The diagnostic test checks the ROM, RAM, AUX port, IN/OUT port, internal battery, keyboard and LCD for proper operation. Additionally it displays power source voltage, contrast and dimmer settings and program version number.

1. Press the [MENU] key once or twice to open the menu.
2. Select SYS SETUP and then press the [ENT] key.
3. Select TEST? and then press the [ENT] key. You are asked if you are ready to start the test.

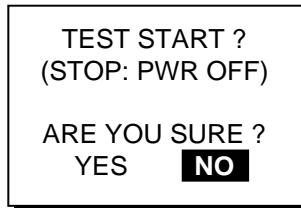

TEST START screen

4. Press ◀ to select YES and then press the [ENT] key to start the test.
5. The equipment tests the ROM, RAM, AUX port, IN/OUT port and internal battery, displaying the results as OK or NG (No Good). For any NG contact your dealer for advice. “ - ” is shown where no data is fed to a port. Additionally the test displays the program version numbers, power source voltage and contrast and dimmer settings.

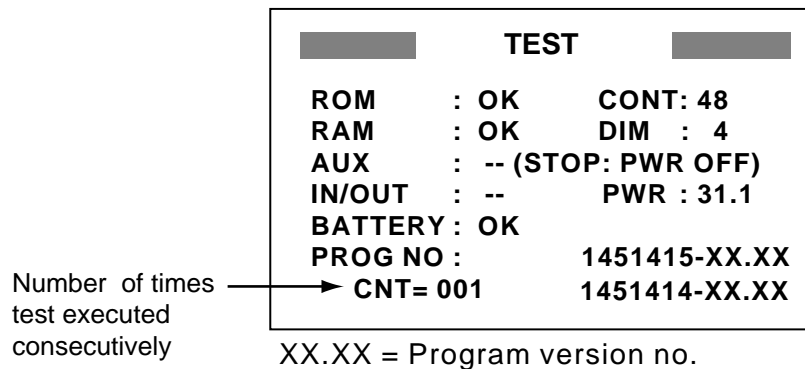

XX.XX = Program version no.

TEST display

6. After the equipment has checked the items mentioned above, a beep sounds and the message PUSH KEY appears at the top right-hand corner.
7. Press each key and cursor pad arrows one by one. The name of the key or cursor pad arrow pressed momentarily appears at the top right-hand corner if the key or cursor pad is functioning properly.

Note: If no control is operated within approx. five seconds, the equipment automatically proceeds to step 8.

- The equipment beeps and then displays the following message to inform you that it is now going to check the LCD:

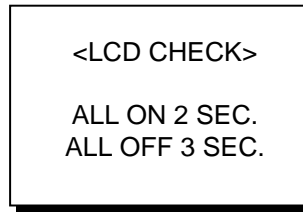

LCD CHECK screen

- The LCD is checked and then the entire test is repeated. To stop the test, turn off the power.

2.4 When BATTERY ALARM! Appears

A lithium battery (type: CR2354-1F2, code no.: 000-142-305) is installed on the circuit board inside the display unit, and it preserves data when the power is turned off. The life of the battery is about 3-5 years. When its voltage is low BATTERY ALARM! appears on the display to alert you. When this happens, have a qualified technician replace the battery, following the procedure below.

- Press the [MENU] key once or twice to open the menu.
- Select SYS SETUP and then press the [ENT] key.

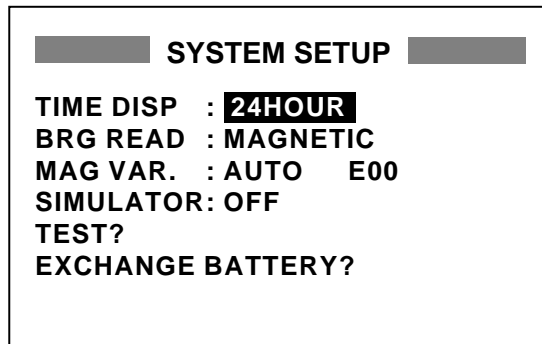

SYSTEM SETUP menu

- Select EXCHANGE BATTERY? and then press the [ENT] key. The display shows the following message:

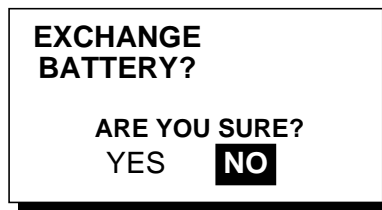

Exchange battery window

- Press ◀ to select YES and then press the [ENT] key. The following display appears. (At this time, the contents of the RAM are temporarily moved to the flash memory.)

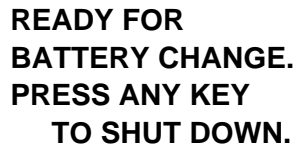

**READY FOR
BATTERY CHANGE.
PRESS ANY KEY
TO SHUT DOWN.**

Battery exchange confirmation window

5. Press any key to shut down the equipment.
6. Have a qualified technician replace the battery.

2.5 Clearing Backup Data

You may clear all backup data (menu settings, trip, graph and odometer readings, etc.) to start afresh.

1. Press the [MENU] key once or twice to open the main menu.
2. Select RESET and then press the [ENT] key.
3. Select ALL BACKUP DATA? and then press the [ENT] key.

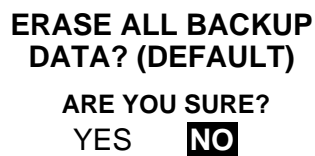

**ERASE ALL BACKUP
DATA? (DEFAULT)
ARE YOU SURE?
YES **NO****

Prompt for erasure of backup data

4. Press ◀ to select YES and then press the [ENT] key. The following display appears.



**RESTART FOR
ERASING DATA.

HIT ANY KEY.**

Prompt for restarting

5. Hit any key to erase all backup data. A beep sounds and then backup data is cleared.

MENU TREE

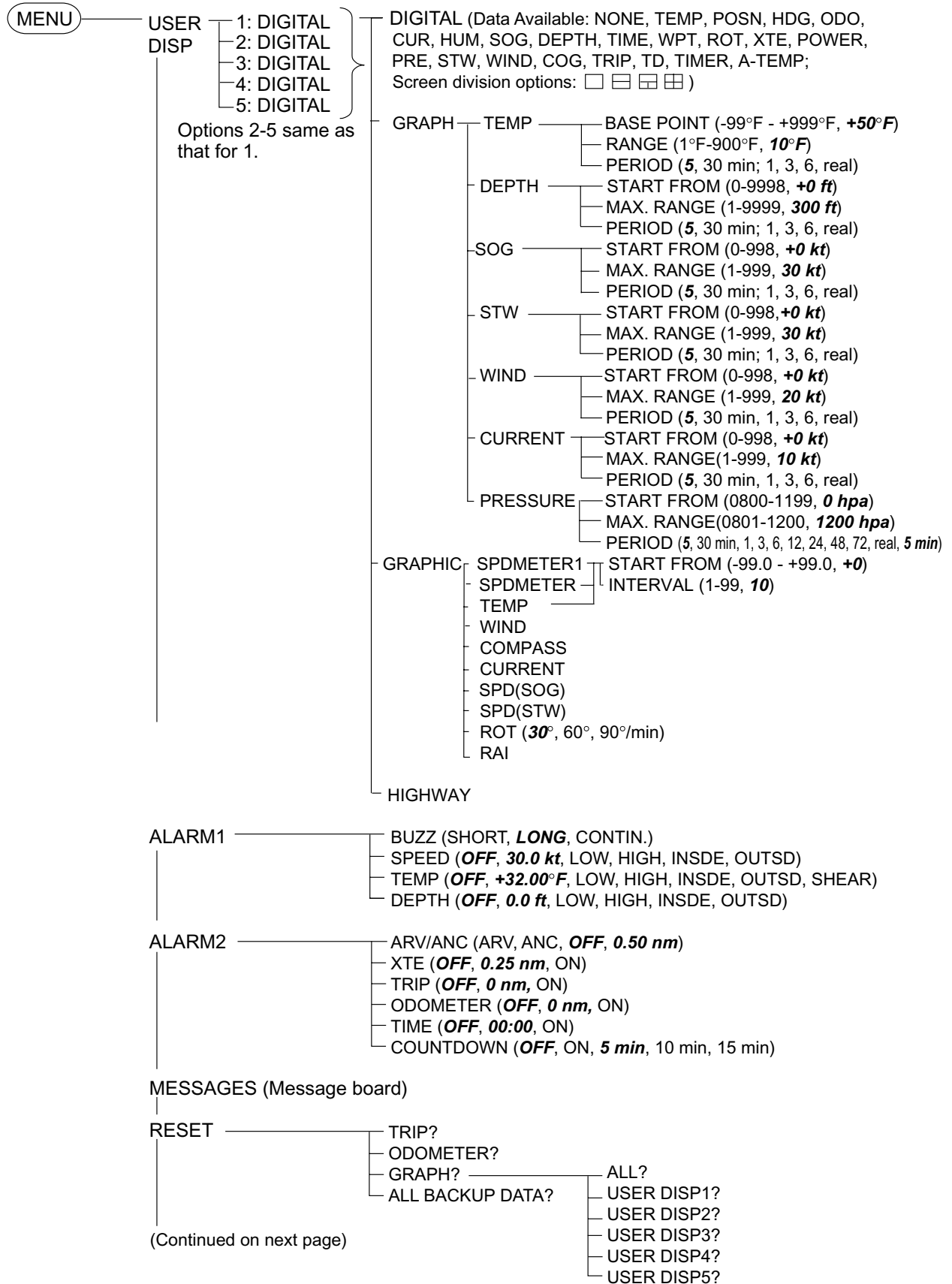

(Continued from previous page)

OFFSETS	TIME DIFF (-13:30 - +13:30, +00:00)
	SPEED(SOG) (-99.9 - +99.9, +0.0 kt)
	SPEED(STW) (-99.9 - +99.9, +0.0 %)
	TEMP (-99.9°F - +99.9°F, +0.00°F)
	DEPTH (-999.9 - +999.9, +0.0 ft)
	WND DIRECT (-179.9° - +179.9°, +0.0°)
	WND SPEED (-99.9 - +99.9, +0.0 kt)
SYS SETUP	TIME DISP (12 HOUR, 24 HOUR)
	BRG READ (MAGNETIC , TRUE)
	MAG VAR. (AUTO , MANUAL)
	SIMULATOR (OFF , ON)
	TEST?
	EXCHANGE BATTERY?
I/O SETUP	IN/OUT PORT (OFF , IN/OUT, AUX, BOTH)
	AUX PORT (OFF , IN/OUT, AUX, BOTH)
	POWER OUT (OFF , ON)
	IN/OUT PORT } For selecting data sentence. See * below.
	AUX PORT }
TD SETUP	DISPLAY (XX.XXX' , XX'XX.X", LORAN C TD, DECCA TD, LORAN A TD)
	LORAN C (Set Loran C chain and station pair. Default: 7980-23-43)
	ΔTD1, ΔTD2 (-99.9 - +99.9, +00.0)
	DECCA (Set Decca chain and station pair. Default: 25-G-P (Skagerrak))
	ΔTD1, ΔTD2 (-9.99 - +9.99, +0.00)
	LORAN A (Set Loran A chain and station pair. Default: 2S3-2S4)
	ΔTD1, ΔTD2 (-99.9 - +99.9, +00.0)
LANGUAGE	ENGLISH , Others
UNITS	TEMP (°C, °F) (XX.XX , XX.X)
	DIST/SPD (NM, KT ; KM, KM/H; SM, MPH)
	DEPTH (M, FT , FA, PB)
	WIND SPD (KT , KM/H, MPH, M/S)
	WIND (OFF , 1, 5, 10 min)
	(TRUE , APP)
HDG SETUP (w/connection of PG-1000, C-2000)	CALIBRATION (YES, NO)
	OFFSET (-90 to +90, 0)
	DAMPING (0 to 3, 1) (C-2000)

*= APB, BWC, BWR, CUR, DBK, DBS, DBT, DPT, GGA, GLC, GLL, GTD, HDT, HDG, HDM, MDA, MTW, MWV, RMB, RMC, ROT, VBW, VDR, VHW, VTG, VWR, VWT, XTE, ZDA

LORAN C/ A CHAINS

Loran C

Chain	GRI	S1	S2	S3	S4	S5
Central Pacific	4990	11	29	–	–	–
Canadian East Coast	5930	11	25	38	–	–
Commando Lion (Korea)	5970	11	31	42	–	–
Canadian West Coast	5990	11	27	41	–	–
South Saudi Arabia	7170	11	26	39	52	–
Labrador Sea	7930	11	26	–	–	–
Eastern Russia	7950	11	30	46	61	–
Gulf of Alaska	7960	11	26	44	–	–
Norwegian Sea	7970	11	26	46	60	–
Southeast USA	7980	11	23	43	59	–
Mediterranean Sea	7990	11	29	47	–	–
Western Russia	8000	10	25	50	65	–
North Central USA	8290	11	27	42	–	–
North Saudi Arabia	8990	11	25	40	56	69
Great Lakes	8970	11	28	44	59	–
South Central USA	9610	11	25	40	52	65
West Coast USA	9940	11	27	40	–	–
Northeast USA	9960	11	25	39	54	–
Northeast Pacific (old)	9970	11	30	55	81	–
Icelandic	9980	11	30	–	–	–
North Pacific	9990	11	29	43	–	–
Suez	4991	10	24			
England, France	8940	12	30			
Northwest Pacific	8930	11	30	50	70	
Newfoundland East Coast	7270	11	25			
Lessay	6731	10	39			
BØ	7001	11	27			
Sylt	7499	11	26			
Ejde	9007	10	23	38		
Saudia Arabia North	8830	11	25	39	56	
Saudia Arabia South	7030	11	25	37	55	

Loran A

Loran A station pair (Cannot enter same pair.)
1L0, 1L1, 1L4, 1L5, 1L6, 1L7, 1S1, 1S2, 1S3, 1S4, 1S6, 2H5, 2H6, 2S0, 2S1, 2S2, 2S3, 2S4, 2S5, 2S6, 2S7

DECCA CHAINS

Chain No.	Chain	Chain code	Location	Chain No.	Chain	Chain code	Location
01	South Baltic	0A	Europe	25	Skagerrak	10B	"
02	Vestlandet	0E	"	26	North Persian Gulf	5C	Persian Gulf & India
03	Southwest British	1B	"	27	South Persian Gulf	1C	"
04	Northumbrian	2A	"	28	Bombay	7B	"
05	Holland	2E	"	29	Calcutta	8B	"
06	North British	3B	"	30	Bangladesh	6C	"
07	Lofoten	3E	"	31	Saliyah	2F	"
08		3F	"	32	Hokkaido	9C	Japan
09	North Baltic	4B	"	33	Tohoku	6C	"
10	North West	4C	"	34	Kanto	8C	"
11	Trondelag	4E	"	35	Shikoku	4C	"
12	English	5B	"	36	Hokuriku	2C	"
13	North Bothnian	5F	"	37	Kita Kyushu	7C	"
14	Southern Spanish	6A	"	38	Namaqualand	4A	Southern Africa
15	North Scottish	6C	"	39	Cape	6A	"
16	Gulf of Finland	6E	"	40	Eastern Province	8A	"
17	Danish	7B	"	41	South West Africa	9C	"
18	Irish	7D	"	42	Natal	10C	"
19	Finmark	7E	"	43	Dampier	8E	Australia
20	French	8B	"	44	Port Headland	4A	"
21	South Bothnian	8C	"	45	Anticosti	9C	Northern America
22	Hebridean	8E	"	46	East Newfoundland	2C	"
23	Frisian Islands	9B	"	47	Cabot Strait	6B	"
24	Helgeland	9E	"	48	Nova Scotia	7C	"

**SPECIFICATIONS OF MULTI-DISPLAY
RD-30**

1 GENERAL

- 1.1 Display 95 x 60 mm (120 x 64 dot matrix)
- 1.2 Display Menu 1/2/3/4 data, Highway, Graph, Alphanumeric
- 1.3 Alphanumeric Data Water temperature, Water depth, Ship's speed, Wind speed, Current speed/bearing

2 I/O INTERFACE

- 2.1 Data format IEC 61162-1/NMEA 0183
- 2.2 Input/output Data
 - Own ship's position GGA>RMC>GLL
 - Time ZDA>GGA
 - Ship's speed (SOG) VTG>VBW
 - Ship's speed (STW) VHW>VBW
 - Wind speed/bearing True: MWV (T)>VWT>MDA, Appearance: MWV (R)>VWR
 - Water temperature MTW>MDA
 - Water depth DPT>DBT>DBS>DBK
 - Course VTG>RMC
 - Heading HDT>HDG>HDM>VHW
 - Destination RMB>BWR>BWC
 - Current speed/bearing CUR>VDR
 - Time difference GLC>GTD
 - Pressure/Humidity MDA
 - Cross track error XTE>APB>RMB
 - Rate of Turn ROT
 - Rudder Angle RSA
 - UTC and time to destination waypoint ZTG

3 POWER SUPPLY

- 3.1 Display Unit 12-24 VDC: 200-105 mA

4 ENVIRONMENTAL CONDITION

- 4.1 Ambient Temperature -15°C to +55°C
- 4.2 Relative Humidity 95% at 40°C
- 4.3 Waterproof IPX5
- 4.4 Vibration IEC 60945

5 COATING COLOR

- 5.1 Display Unit Cover: 2.5GY5/1.5, Panel: N3.0

This page is intentionally left blank.

INDEX

*	
* key	1-14
A	
Alarms	
anchor watch	1-18
arrival	1-18
audio	1-15
countdown.....	1-20
depth	1-17
messages	1-21
odometer.....	1-20
speed	1-16
time	1-20
trip	1-19
water temperature.....	1-16
XTE (cross track error)	1-19
Anchor watch alarm	1-18
Arrival alarm	1-18
Audio alarm.....	1-15
B	
Backup data erasure.....	2-4
Battery replacement.....	2-3
Bearing reference	1-28
C	
Contrast	1-2
Controls.....	1-1
Countdown alarm.....	1-20
D	
Depth alarm	1-17
Digital display setup	1-9
DIM key.....	1-2
Dimmer	1-2
DISP key	1-3
G	
Graph display	
sample	1-4
setup	1-11
Graphic display	
sample	1-5
setup	1-13
H	
HDG SETUP menu.....	1-30
Highway display.....	1-6
I	
I/O SETUP menu	1-27
M	
Maintenance	2-1
Magnetic variation.....	1-29
Menu tree.....	M-1
Messages	1-21, 2-1
O	
Odometer alarm.....	1-20
OFFSETS menu	1-24
P	
Position format.....	1-26
PWR switch	1-2
R	
RESET menu.....	1-22
Resetting indications	1-22
Rx data display	1-14
S	
Simulation mode.....	1-27
Speed alarm.....	1-16
System configuration	iv
T	
TD SETUP menu	1-26
Test	2-2
Time alarm	1-20
Time format.....	1-25
Trip alarm.....	1-19
U	
UNITS SETUP menu.....	1-23
Units of measurement.....	1-23
W	
Water temperature alarm.....	1-16
Wind.....	1-23
X	
XTE (cross track error) alarm	1-19
Z	
Zoom.....	1-7